MONOLITHIC THREE-PHASE UPS UL 480V

Innovation that works around you

MegaFlex – the best in power protection



- Market-leading energy efficiency
- Monolithic UPS with capability up to 1.6 MW
- Monolithic Three-Phase UPS UL 480V
- Footprint reduction up to 40 percent

As the market leader in UPS technology, ABB developed the MegaFlex uninterruptible power supply for the UL market with power ranges from 1.2 to 1.6 MW.

MegaFlex is fully adaptable, highly efficient, and easy to install and maintain. High power protection has been taken to a whole new level with highest power density and energy efficiency.

Table of contents

004	Introducing MegaFlex UPS
006	The MegaFlex UPS offering
008	Flexible approach
009	Optimized efficiency
010	Reliable operations
011	World-class innovation
012	Ultimate space and energy savings
013	Control and monitoring
014	Tested and trusted
014	Services
015	Technical specifications

Meet the best and most reliable UPS on the market

The MegaFlex UPS

The on-line double conversion MegaFlex UPS provides the best power protection for your critical infrastructure from 1,200 kW to 1,600 kW for UL applications.

This monolithic UPS is specifically designed for critical high-density computing environments across private and public enterprise, as well as data centers for colocation, hosting cloud and telecommunication centers.

Technology based on ABB's **redundant parallel architecture™ (RPA)** allows the UPS to run in a parallel arrangement, eliminating any single point of failure with true redundancy. RPA reduces operating footprint and provides a scalable paralleling approach that increases system reliability. It also eliminates the need for external paralleling equipment or centralized bypass and master control.

The ABB MegaFlex UPS delivers up to 97% efficiency in double conversion mode and 99% in eBoost operating mode. The system efficiency substantially reduces operating and cooling costs, reducing cost of ownership and providing more effective power usage than conventional UPS systems.

Footprint savings up to

40%

Efficiencies up to

97%

Design life up to

15 year

including consumable components

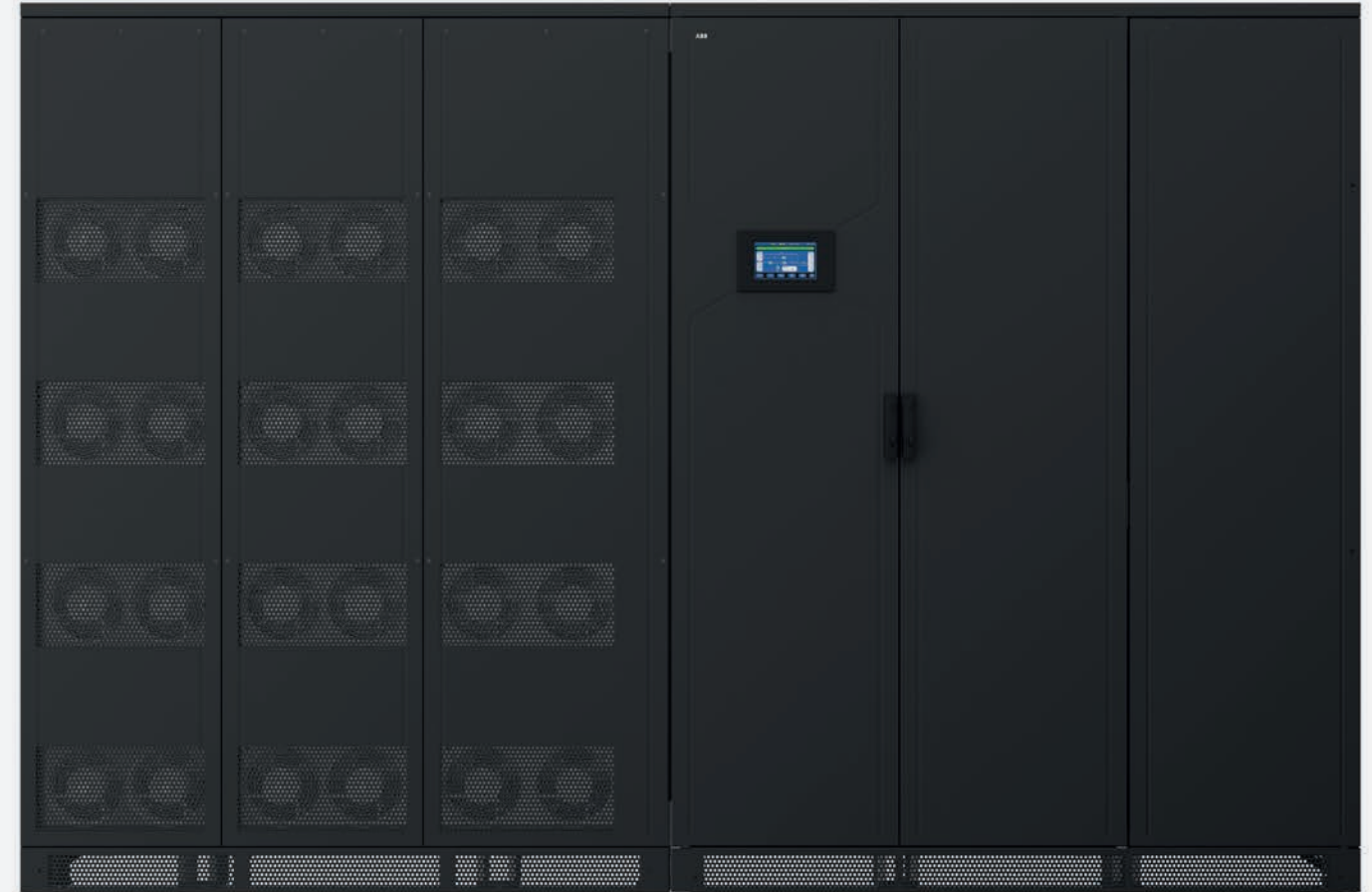

MegaFlex UL designed for large high power mission critical data centers.

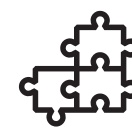

Flexible, scalable power

From 1200kW to 1600 kW based on power block of 400 kW



Sustainable power technology

Best-in-class efficiency of up to 97% in double conversion mode and up to 99% in VFD mode

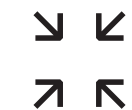

Maximized power density in compact monolithic design

Up to 40% footprint savings with ultra-high kW per square foot



Simple and safe installation

Pre-engineered interconnection between power section and power distribution cabinet enables trouble-free installation



Maximized availability using proven RPA technology

RPA provides complete redundancy of all UPS modules in parallel, eliminating single points of failure



Up to 15 year design life on consumable components

Reduces the cost of system replacements over the product lifespan

The MegaFlex UPS offering

As the most efficient technology of its kind, the MegaFlex UPS offers a vast range of benefits to its user. From effortless installation to industry-leading innovation, explore how your facility can harness its exceptional performance.

01



Flexible approach

- Single module capacity from 1,200 kW to 1,600 kW; core power blocks of 400 kW
- Redundant parallel architecture with distributed static bypass
- Multi-module ready offering: N+1, 2N, 2N+1, N+N, 3N/2, and a distributed redundant 'catcher' design
- Collaborative, customer-centered approach

03



Reliable operations

- RPA technology eliminates single points of failure in parallel systems
- Ease of operation with local and remote real-time monitoring
- Proven high-power transformerless technology

02



Optimized efficiency

- Minimized energy losses, heat dissipation and electricity cost in double conversion, up to 97%
- High energy efficiency operation in eBoost mode, up to 99%

04



World-class innovation

- Proven technology from world-leading R&D experts
- Power conversion technology for high power density
- eBoost (VFD) mode for premium efficiency



Simple installation and serviceability

- Easy front and top service access
- Modular sub-assemblies facilitate ease of service and lower MTTR
- Fast consumable replacement - all accessories in one cabinet
- Remote UPS monitoring
- Consumable parts design life up to 15 years

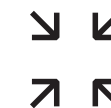

Ultimate space & energy savings

- Market leading maximization of power density
- Up to 40 percent footprint savings inside high-density computing rooms
- 25 percent reduced energy consumption kWh over the product life span



01

Flexible approach

As your power requirements increase, you need a UPS that grows with your infrastructure. MegaFlex provides a scalable paralleling approach, with module capacity ranging from 1,200 kW to 1,600 kW, up to 4 modules for capacity or redundancy.



Flexible approach

- Ease-of-use for operations personnel
- Simple maintenance, easy system upgrade
- Can be paralleled with up to four systems

1,200 kW ————— 1,600 kW

Flexible system architecture ready: N+1, 2N, 2N+1, N+N, 3N/2, and catcher systems. ABB catcher system configurations allow redundancy and reliability and improve total costs of ownership.

The MegaFlex UL UPS is part of ABB's broad range of products and integrated solutions that ensure data centers operate with optimum reliability and efficiency. From power distribution units to static transfer switches and uninterruptible power supply systems, ABB can optimize your centralized power protection design.

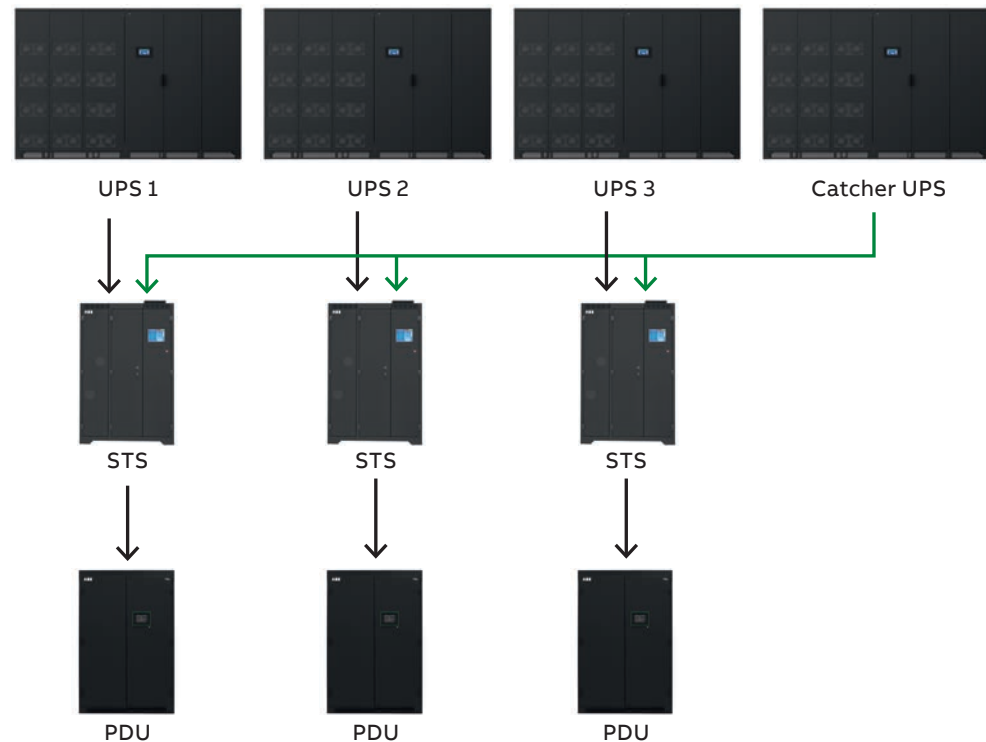

02

Optimized efficiency

Running a facility with high energy demands means that every percentage point of energy saved represents significant cost savings and a reduction in CO₂ emissions.



Optimized efficiency

The MegaFlex UPS solution combines the highest efficiency ratings available with the smallest footprint.

- The best power density on the market
- Double conversion operating mode with efficiency of up to 97 percent, rising to 99 percent efficiency in VFD eBoost mode
- Up to 40 percent footprint savings with high power density
- Optimized efficiency in partial-load conditions

Energy consumption is a critical issue for IT organizations as data center energy demands continue to grow. eBoost technology allows IT organizations to reduce energy consumption costs without sacrificing the system reliability that keeps their center running.

Double conversion (VFI) - 3 level converters

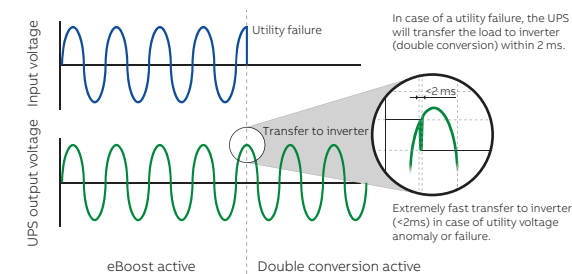
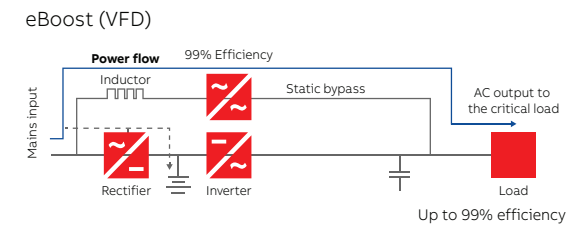

Efficiencies up to **99%** in eBoost operation

60% Lower power losses

CO₂ emission reduction in eBoost mode **1,000 tons**

15 year design and operating life

03

Reliable operations

Critical, high-density computing environments demand a combination of assured uptime and the highest safety standards to ensure both assets and people are protected.



- Comprehensive monitoring capabilities allowing inclusive communication to ABB service networks
- Enhanced power measurement, providing comprehensive data to track energy consumption
- Modular sub-assemblies including capacitors and fans facilitating ease of service and lowering MTTR
- Easy front and top access to all system components reduces repair and maintenance time
- Up to 15 year design life on consumable components

Maintenance made easy

Serviceability has never been easier, thanks to the MegaFlex UPS's innovative design. A common 400 kW building block blueprint has been expertly engineered to optimize accessibility and to reduce the possibility of human error.

Designed for ease of use from the moment of installation, the MegaFlex two-cabinet compartmented architecture simplifies uniform structural support and easy installation. The power and distribution cabinets are factory pre-wired, minimizing onsite connection points and accelerating onsite logistics and commissioning.

RPA (Redundant parallel architecture) technology

RPA provides parallel system architecture for redundancy and no single point of failure. This means that if the lead UPS fails to operate, another UPS automatically takes on the leadership role. And, if any other UPS fails to operate, its load is automatically redistributed to the others.

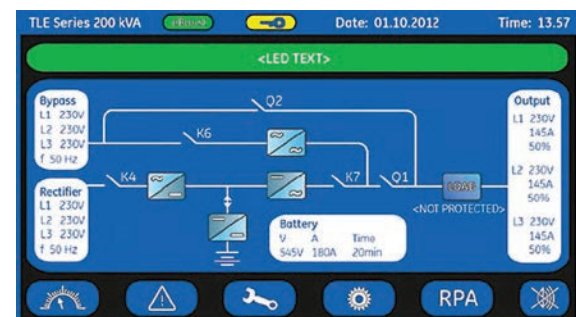
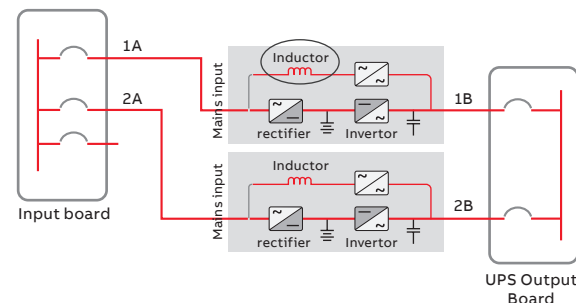

04

World-class innovation

Meeting the increasing power demands of modern data centers requires a continuous flow of clean, sustainable power and system-wide resiliency. With its world-class research and development capability and 130 years history of innovation, ABB is uniquely placed to work with you to support power quality and availability.



World-class innovation

Enhanced resiliency increases a power structure's failure-prevention capabilities and its ability to keep running despite faulty equipment or software.

The MegaFlex UPS and accompanying ABB support infrastructure – such as intelligent switchgear, smart sensors, cloud-based predictive maintenance and enterprise and site-specific monitoring – deliver the high-level of system-wide resilience essential to the global data center industry.

- Support of ABB's full product portfolio
- Smart grid to regulate energy consumption

Innovation in resiliency

As data centers respond to new trends in hybrid and distributed architectures, real-time data replication and advances in virtualization, resiliency becomes increasingly essential.

Measures taken to improve resiliency also have other benefits. For example, a good monitoring strategy allows for predictive insight that can not only flag equipment replacement issues but also enhance self-diagnostics. This in turn reduces downtime and mitigates risk through human error.

This approach also allows remote monitoring of the plant's energy consumption, making the implementation of energy management strategies easier, faster and more cost-effective.



Ultimate space and energy savings

The MegaFlex 480V UL system delivers an industry leading, monolithic high-power density cabinet design with an optimized, industry leading footprint. This compact system stacks three, 400 kW power blocks for 1.2 MW, and four, 400 kW power blocks for 1.6 MW within one UPS cabinet delivering reliable power with reduced energy losses.



ABB vs. Market in width @ 1200 kW



ABB vs. Market in width @ 1600 kW

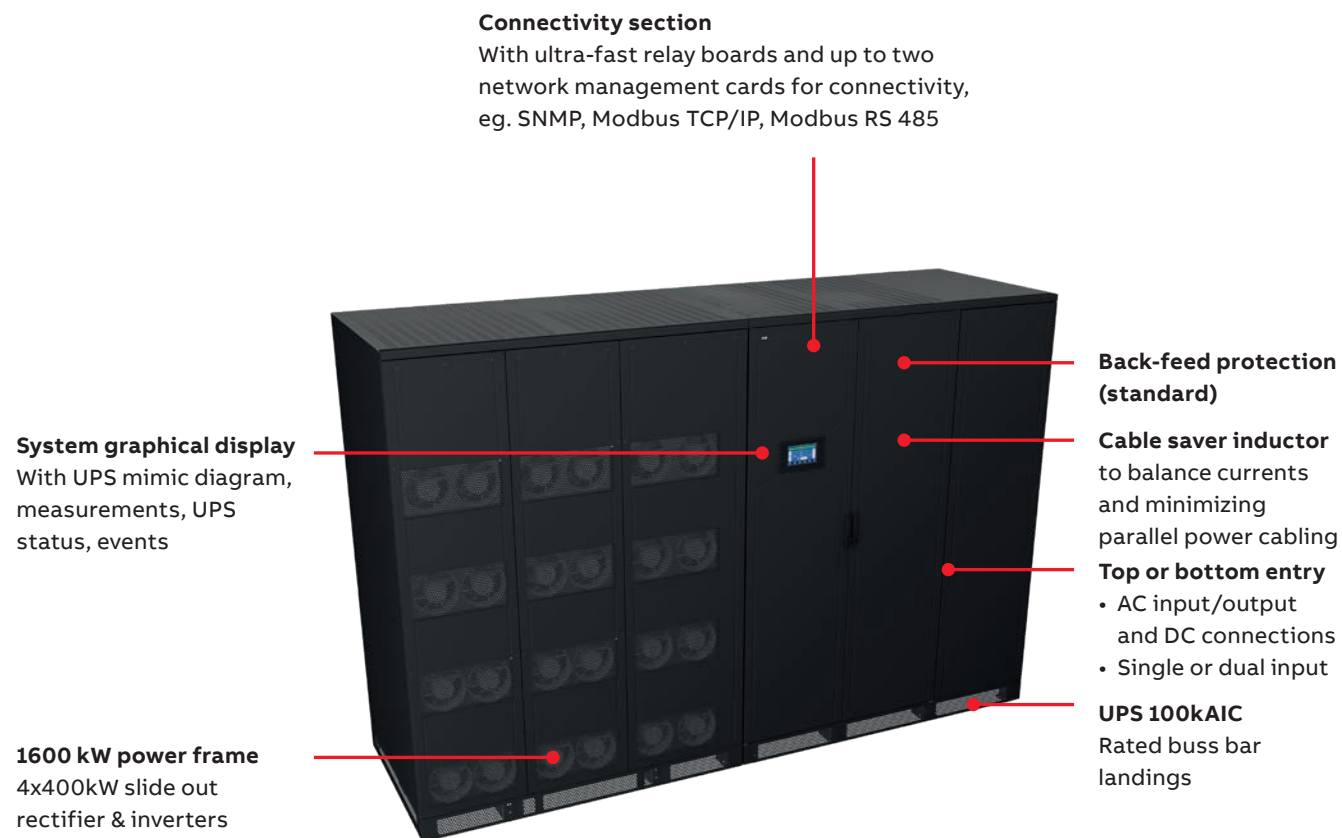

Control and monitoring

The MegaFlex UPS's visual interface allows the operator to observe measurements, events and alarms onscreen for a comprehensive overview of operations.

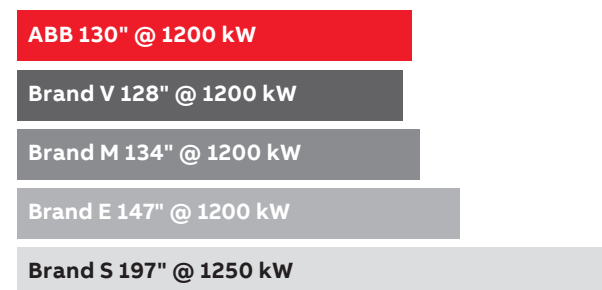

Control and monitor

Display variables include:

- Input, output and battery voltage and currents
- Output kW, kVA

These systems also integrate with the ABB Ability™ Data Center Automation platform, enabling a proactive, holistic approach across operations.

Additional control and monitoring features:

- I/O dry ports
- Dry inputs for remote shutdown
- Generator, operational and external switchgear
- SKRU Interlocks
- Battery cabinet temperature sensor

All UPS measurements are easily accessed remotely with a standard web browser via SNMP, Modbus TCP/IP or Modbus RS 485.

Measurements and alarms are also made accessible to other integrated systems including electrical power monitoring system (EPMS), the building management system (BMS) and data center infrastructure management (DCIM).

The flow of information from the UPS

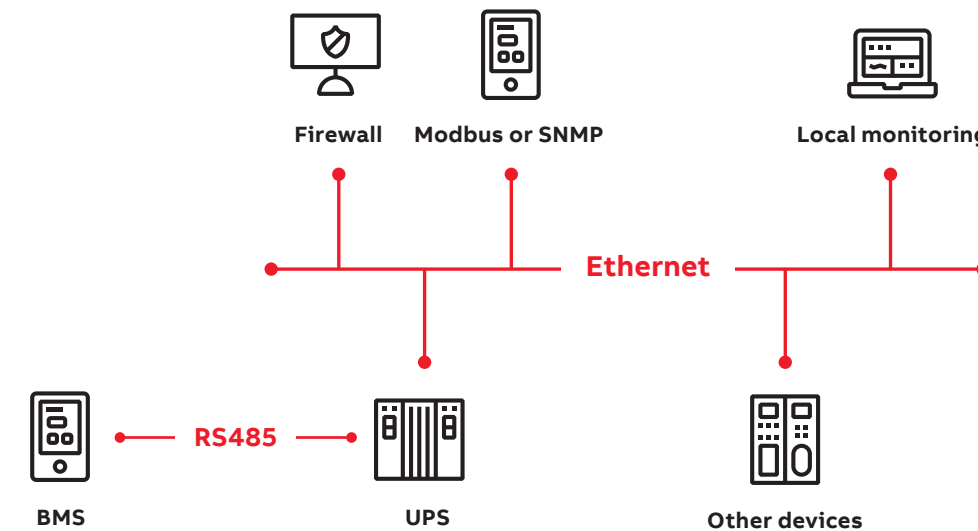

Tested and trusted

Comprehensive testing is crucial, which is why companies routinely test individual products before they leave the factory.

But as our customers know, there are often unexpected operating conditions once devices are integrated into a real-life system. To address this, ABB maintains extensive customer witness testing programs at its Swiss and US manufacturing facilities.

ABB's customers have facility access for:

- Infrastructure flexible testing of up to 5 MW
- UPS testing with associated equipment – like switchgear, static transfer switches, and transformers – for smooth system integration and transition to onsite infrastructure
- Testing center designed to test the largest UPS configurations as a single entity
- Overseeing the entire test process in a private and dedicated conference and high-power testing environment
- Customers can attend UPS factory witness test in person or virtually with remote system



Services

With a global presence in over 100 countries, ABB's service engineers are committed to supporting you wherever you are in the world.



Our UPS service portfolio is designed to maximize your return on investment, keeping equipment operating at its highest efficiency and availability throughout its lifetime. We work closely with our team of R&D experts to develop the most advanced service technologies that ensure proactive product life-cycle management.

Our services include:

- Installation and commissioning
- Repairs
- Spares and consumables
- Extensions, upgrades and retrofits
- Replacement
- Training
- Service agreements
- Advanced services including predictive maintenance
- Factory evaluations

Technical specifications

General data			
System power rating [kW]	1,200	1,500	1,600
Core power rating [kW]	400		
Topology	Online double conversion		
Parallel system capacity	Up to 4 UPS systems via RPA Decentralized Architecture		
Static Bypass Inductor (Standard)	Up to 25% more flexibility on cable length in case of RPA system.		
Cable entry	Top or bottom		
Serviceability	Front and top service access		
HRG Ready	Yes		
Input Connections	Single or Dual Feed		
Short Circuit Withstand Rating	100 kAIC		
Static Bypass	100% Rated – Continuous Duty		
Cabinet color	RAL 9005 (black)		
Input			
Nominal input voltage	480 VAC, 3-ph, 4 W + ground or 3 W + ground		
Voltage tolerance	-15% to +15%		
Current distortion THDi	<3.0% 100% load normal mode – linear		
Frequency range	60 Hz +/-10%		
Power factor	0.99		
Output			
Rated output voltage	480 V ph-ph / 277 V ph-N		
Voltage tolerance	Static: +/-1% Dynamic (step load 0%-100%-0) +/-3 Dynamic (step load 0%-50%-0) +/-2		
Voltage distortion THDu	<3 @ 100% load-normal mode – linear <5 @ 100% load-normal mode – non-linear		
Frequency	60 Hz		
Rated power factor	1.0		
Efficiency			
Double conversion (VFI)	Up to 97%		
eBoost Mode (VFD)	Up to 99%		
Environment			
Protection rating	IP20		
Storage temperature	-13 to 131°F / -25 to 55°C		
Operating temperature	32 to 104°F / 0 to 40°C		
Altitude without de-rating	Up to 1,000 m		
Altitude with de-rating	1,500 m: -2.5% / 2,500 m: -2.5% 1,500 m: -2.5% / 1,500 m: -2.5%		
Acoustic noise at 1 m	<80 dBA		
Communications			
User interface	System graphical touch screen		
Communication ports	RS232, SNMP & Modbus		
Customer interface	Remote shutdown, gen-set interface, external bypass contact		
Batteries			
Types	Lithium ion, VRLA, VLA, NiCd		
Nominal Battery Bus	480V (240 Cell)		
Standards			
Safety	ETL as tested to UL1778 / EN 62040-1		
EMC	C3		
Manufacturing	ISO 9001:2015, ISO 14001:2015, OHSAS18001		
Weight, dimensions			
Weight [lbs] [kg]	8,157 lbs / 3,700 kg	9,039 lbs / 4,100 kg	9,039 lbs / 4,100 kg
Dimensions w x h x d (in) (mm)	129.92 x 86.61 x 39.37 in 3,300 x 2,200 x 1,000 mm	129.92 x 86.61 x 39.37 in 3,300 x 2,200 x 1,000 mm	129.92 x 86.61 x 39.37 in 3,300 x 2,200 x 1,000 mm

Changes to the product or to the information contained in this brochure are reserved; so are errors and omissions. Please reference ABB order confirmations and submittal documentation packages for job specific configurations.



—

ABB Inc.

5900 Eastport Boulevard
Richmond, VA 23231
USA

abb.com/ups